

Model TS318-11C55 Thermopile Sensor



- Thermopile IR-Sensor
- For Contactless Temperature Measurement
- Single Element
- Small Package for Ear Thermometer
- High Signal
- Flat Filter
- Accurate Reference Sensor

DESCRIPTION

Thermopiles are mainly used for contactless temperature measurement in many applications. Their function is to transfer the heat radiation emitted from the objects into a voltage output.

FEATURES

- High Signal
- NTC Reference Sensor
- Small TO-18 Package
- 5.5 μ m Long Wave Pass Filter

APPLICATIONS

- Medical
- Ear Thermometer

ABSOLUTE MAXIMUM RATINGS

Parameter	Symbol	Min	Typical	Max	Unit	Description
Storage Temperature	T _S	-20	+20	+85	°C	permanent
Storage Temperature	T _S	-20	+20	+100	°C	non permanent

Model TS318-11C55 Thermopile Sensor

PERFORMANCE SPECS

Parameter	Symbol	Value	Unit	Condition
Operating Ambient Temperature	T_{Amb}	-20 to +85	°C	permanent
Operating Ambient Temperature	T_{Amb}	-20 to +100	°C	non permanent
Package		TO-18		
Absorber Area	A	0.8×0.8	mm ²	
Thermopile Resistance	R_{TP}	70 ± 30	k Ω	$T_{Amb} = +25\text{ }^{\circ}\text{C}$
Temperature Coefficient of Thermopile Resistance	TCR_{TP}	-0.06 ± 0.04	%/K	$T_{Amb} = +25\text{ }^{\circ}\text{C}$ to $+75\text{ }^{\circ}\text{C}$
Voltage Response	V_{TP}	8.4 ± 2.1	mV	$T_{Amb} = +25\text{ }^{\circ}\text{C}$, $T_{Obj} = +100\text{ }^{\circ}\text{C}$, DC, totally filled field of view
Temperature Coefficient of Voltage Response	TCV_{TP}	-0.45 ± 0.08	%/K	$T_{Amb} = +25\text{ }^{\circ}\text{C}$ to $+75\text{ }^{\circ}\text{C}$
Noise Equivalent Voltage	NEV	34	nV/Hz ^{1/2}	$T_{Amb} = +25\text{ }^{\circ}\text{C}$
Rise Time	τ_{63}	12 ± 5	ms	
Ambient Temperature Sensor		NTC		
Ambient Temperature Sensor Resistance	R_{NTC}	100 ± 5	k Ω	$T_{Amb} = +25\text{ }^{\circ}\text{C}$
Beta Value of NTC	β -Value	$3955 \pm 0.3\%$	K	$T_{Amb} = 0\text{ }^{\circ}\text{C}$ to $+50\text{ }^{\circ}\text{C}$

TYPICAL PERFORMANCE CURVES

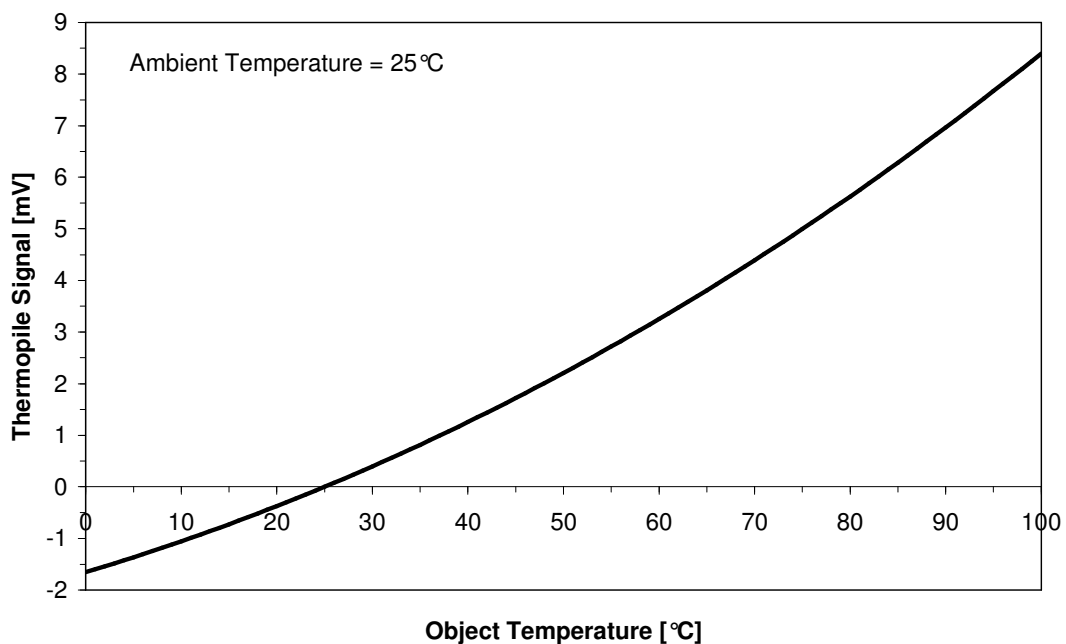

Figure 1: Thermopile signal versus object temperature at 25°C ambient temperature

Model TS318-11C55 Thermopile Sensor

OPTICAL CHARACTERISTICS

Parameter	Symbol	Value	Unit	Description
Field of View	FOV	110	deg	at 50% of maximum signal

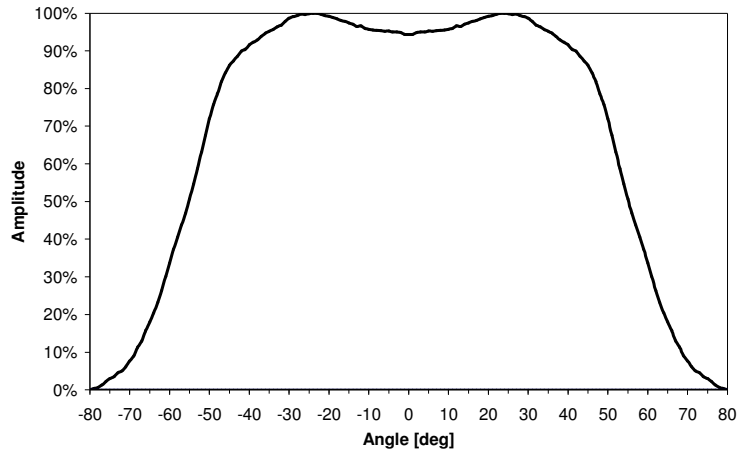

Figure 2: Field of View Curve

FILTER CHARACTERISTICS

Parameter	Symbol	Value	Unit	Description
Transmission Range	LWP	≥ 5.5	μm	Long Wave Pass
Transmission	$T_{7.5 \dots 13.5\mu\text{m}}$	≥ 77.0	%	at 7.5 ... 13.5 μm
Transmission Blocking Average	$T_{\text{AVG} \leq 4.0\mu\text{m}}$	< 0.1	%	Average $\leq 4.0\mu\text{m}$
	$T_{\text{AVG} 4.0 \dots 5.0\mu\text{m}}$	< 0.5	%	Average 4.0 ... 5.0 μm
Transmission Blocking Absolute	$T_{\text{ABS} \leq 4.0\mu\text{m}}$	< 1.0	%	Absolute $\leq 4.0\mu\text{m}$

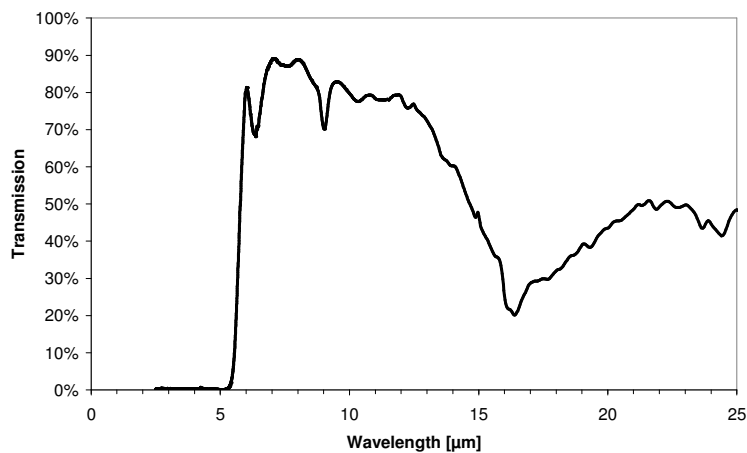

Figure 3: Filter transmission curve

Model TS318-11C55 Thermopile Sensor

ELECTRICAL CONNECTIONS

Pin	Symbol
1	TP +
2	NTC
3	TP -
4	GND

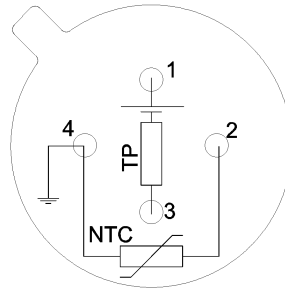
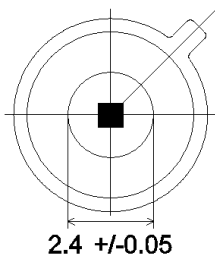

Figure 4: Electrical connections - bottom view of thermopile

MECHANICAL DIMENSIONS

TOP VIEW



SIDE VIEW

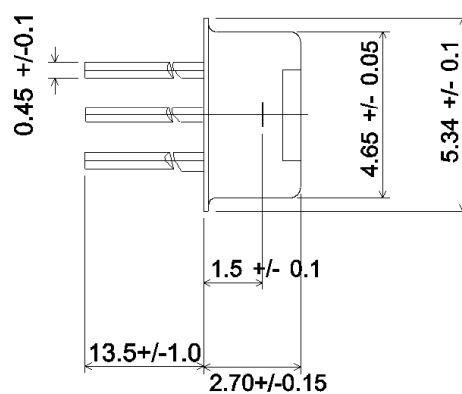

BOTTOM VIEW

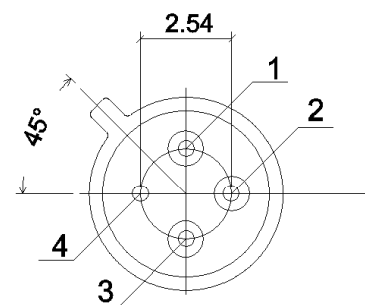

Figure 5: Mechanical dimensions of thermopile

Model TS318-11C55 Thermopile Sensor



ORDERING INFORMATION

Part Descripton TS318-11C55

Part No. G-TPCO-032