

TSEV01C Thermopile Sensor Module

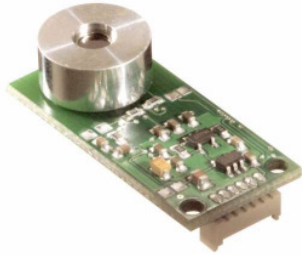

- **Contact less Temperature Measurement**
- **High Accuracy**
- **Small Size**
- **Wide Supply Voltage Range**
- **Digital Interface Bus (I2C)**

DESCRIPTION

TSEV01C is a contact-less temperature measuring system for OEM use based on the detection of infrared radiation.

TSEV01C is equipped with an infrared sensor (Thermopile) in front. The Thermopile Sensor has to be pointed at the target object of interest.

The basic working principle is:

- Detection of infrared radiation with a Thermopile sensor, which turns incoming radiation to an analogue voltage
- Determination of sensor temperature using a thermistor
- Further analogue signal processing and conditioning
- Calculation of ambient and object temperature using a processing unit
- Providing the ambient and objects temperature at digital output bus (I²C)

The TSEV01 is suitable for a wide range of application where non-contact temperature measurement and high accuracy are required.

FEATURES

- 0°C – 50°C Measurement Range
- 4V – 16V Supply Voltage Range
- Up to 0.5°C Accuracy
- 2mA Current Consumption

APPLICATIONS

- Contact less Temperature Measurement
 - Climate Control
 - Industrial Process Control
 - Household Applications
-

TSEV01C Thermopile Sensor Module

ABSOLUTE MAXIMUM RATINGS

Absolute maximum ratings are limiting values of permitted operation and should never be exceeded under the worst possible conditions either initially or consequently. If exceeded by even the smallest amount, instantaneous catastrophic failure can occur. And even if the device continues to operate satisfactorily, its life may be considerably shortened.

Parameter	Symbol	Conditions	Min	Typ	Max	Unit
Supply Voltage	Vcc	Measured versus GND	-0.3		16	V
Operating Temperature	Top		-10		85	°C
Storage temperature	Tstor		-40		85	°C

OPERATING CONDITIONS

Parameter	Symbol	Conditions	Min	Typ	Max	Unit
Supply voltage	Vcc	Measured versus GND	4	5	16	V
Emission Coefficient	ϵ		0.95			

OPERATING CONDITIONS

If not otherwise noted, 25°C ambient temperature, 5V supply voltage and object with $\epsilon = 0.98$ were applied.

Parameter	Symbol	Conditions	Min	Typ	Max	Unit
Field of View	FOV			90		°
Spectral Sensitivity	S		5.5 (cut on)			μm
Supply Current	I	Full ambient temp. range, no output load	1	2	4	mA
Digital Output Clock Rate (I2C)	FI2C		20		50	kHz
Data Output Rate	Fout			1		Hz

OPERATIONAL CHARACTERISTICS

If not otherwise noted, 25°C ambient temperature, 5V supply voltage and object with $\epsilon = 0.98$ were applied.

Parameter	Symbol	Conditions	Min	Typ	Max	Unit
Object Temperature Range	Tobj		0		50	°C
Ambient Temperature Range	Tamb		0		85	°C
Standard Start-Up Time	tStart			5		s
Stabilization Time	tStab			3		min
Accuracy offset – prior to thermal stability time	ΔT_{stab}			2		°C
Accuracy tolerance when 10°C < Tambient < 40°C and after 3 minutes stabilization time	ΔT	16°C < Tobject < 36°C		0.55		°C
		Outside above range		2		°C

TSEV01C Thermopile Sensor Module

MECHANICAL DIMENSIONS

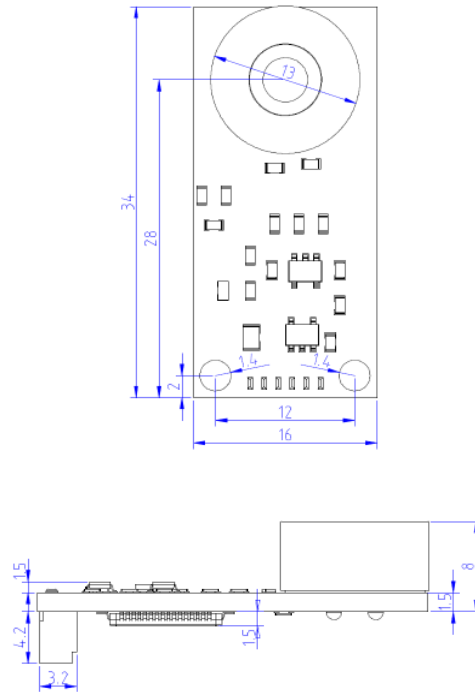

TERMINALS

Connector: Molex 51021-0600 (Farnell-In-One: 1012261, Digikey: WM1724-ND)

Pin	Name	Description	Type
1	NC	Not connected	---
2	NC	Not connected	---
3	SDA	I ² C Data (3.6V)	Interface
4	SCL	I ² C Clock (3.6V)	Interface
5	GND	Ground	Supply
6	VCC	Supply Voltage (5V)	Supply

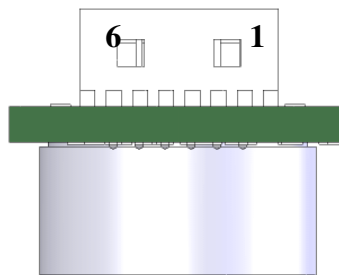

TSEV01C Thermopile Sensor Module

BLOCK DIAGRAM

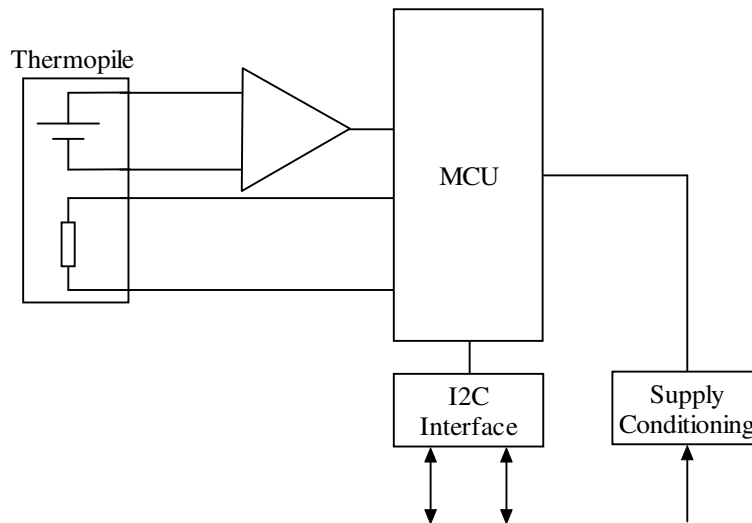

Figure n: Block diagram

TYPICAL PERFORMANCE CURVES

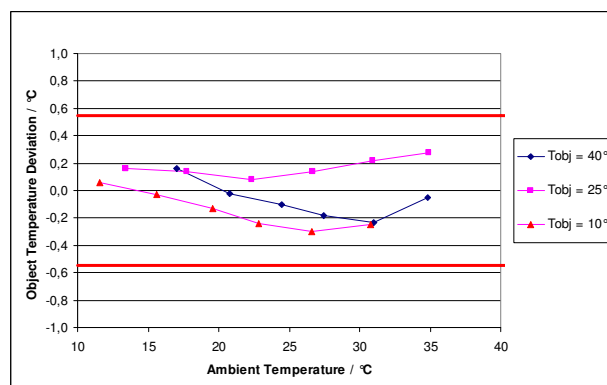

Figure n: typical performance curve

TSEV01C Thermopile Sensor Module

FUNCTION

I²C INTERFACE

This module is always operating in pure slave modus of a two wire interface similar to I²C. The typical baud rate of this device is 20kBit/s. The supported address length is seven bits. The I²C slave address is 54h.

PHYSICAL INTERFACE PARAMETERS

Parameter	Min	Typical	Max	Unit
Baudrate	10	---	50	kBit/s
Address length	---	7	---	Bit
Address (standard)	---	54h	---	---
Input High Level	2	---	3.6	V
Input Low Level	---	---	1	V
Output High Level	2.5	---	---	V
Output Low Level	---	---	1	V

TIMING PARAMETERS

START/STOP

No.	Parameter	Description	Min	Typ	Max	Unit
1	TSU:STA	Start Setup Time	4.7	---	---	μs
2	THD:STA	Start Hold Time	4.0	---	---	μs
3	TSU:STO	Stop Setup Time	4.0	---	---	μs

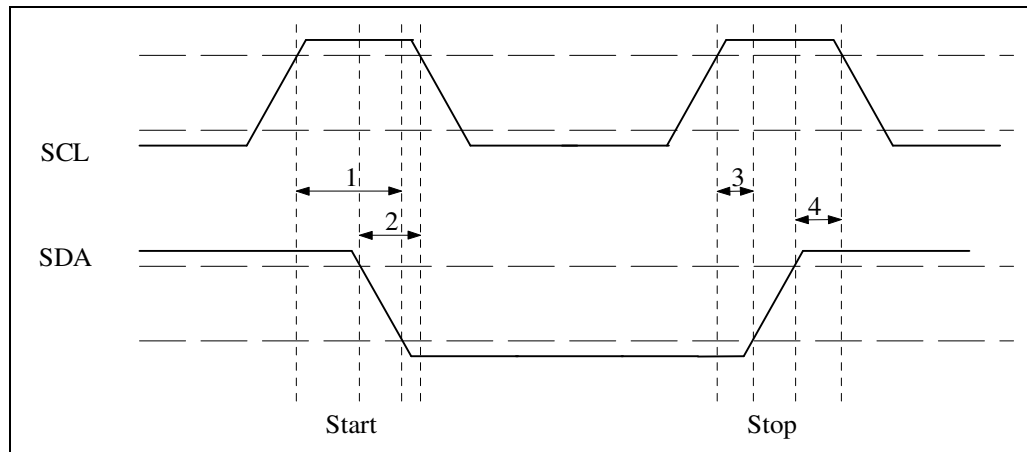

TSEV01C Thermopile Sensor Module

DATA

No	Parameter	Description	Min	Max	Unit
1	THIGH	Clock High Time	4.0	50	μs
2	TLOW	Clock Low Time	4.7	---	μs
3	TR	SDA & SCL Rise Time	---	1	μs
4	TF	SDA & SCL Fall Time	---	0.3	μs
5	THD:DAT	Data Input Hold Time	0.3	---	μs
6	TSU:DAT	Data Input Setup Time	0.25	---	μs
	TBUF	Bus Free Time	4.7	---	μs

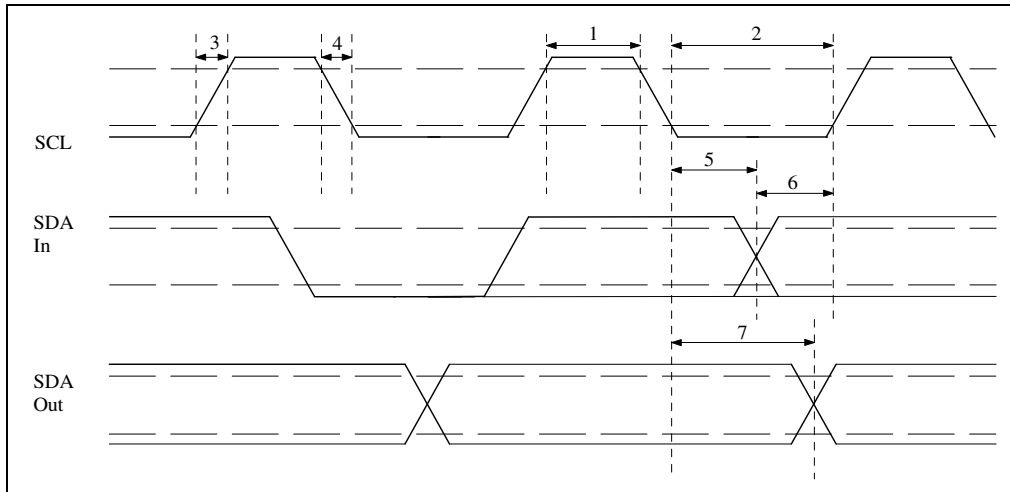

I2C COMMAND REFERENCE

AMBIENT AND OBJECT MEASUREMENT

Please refer following table for I²C commands to read object temperature and ambient temperature. Both values are transmitted in hundredth of degrees.

Command	Description	Reply	Bytes
0xB6	Read object temperature	Object temperature in hundredth of degree	2
0xB5	Read ambient temperature	Ambient temperature in hundredth of degree	2

EXAMPLE OF TEMPERATURE CALCULATION

For reading object temperature send: 0xB6

Return values i.e.: Byte(0) = 0x0E, Byte(1) = 0xAA

Temperature $T_{obj} = (256 * \text{Byte}(0) + \text{Byte}(1)) / 100 = (256 * 14 + 170) / 100 = \underline{37.54}^{\circ}\text{C}$

OUT OF RANGE INDICATION

In case of ambient or object temperature over exceeding specified temperature ranges temperature outputs showing following data:

Command	Description	Reply	Bytes
0xB6	Object temperature > 50 °C	0xFFF0	2
0xB6	Object temperature < 0 °C	0xFFF1	2
0xB5	Ambient temperature > 85 °C	0xFFFF	2
0xB5	Ambient temperature < 0 °C	0xF000	2