

XPC10

High temperature miniature pressure sensor

SPECIFICATIONS

- Ranges 10 to 500 bar [150 to 7 500 psi]
- Absolute, sealed and gauge
- High temp. from -40 up to 220 °C [-40 to 428 °F]
- Stainless steel construction
- For static and dynamic applications
- Linearity up to $\pm 0.25\%$ F.S.

FEATURES

- Low Installation Torque Sensitivity
- M10x1 or 3/8-24UNF thread
- Specific threads lengths on request
- Integrated Amplifier optional
- Titanium body on request
- Optional IP67 Ingress Protection

APPLICATIONS

- Aerospace
- Test benches
- Oven monitoring equipment
- Cooling regulation systems

The **XPC10** is a miniature pressure transducer specifically designed to measure static and dynamic pressures in temperatures from -40 to 220 °C [-40 °F to 428 °F] (unamplified models).

Made of stainless steel, the rugged **XPC10** is suitable for corrosive liquids and gases in a wide variety of harsh environments.

The **XPM10** threaded construction virtually eliminates zero shifts caused by installation torque.

The core technology of the **XPC10** consists of a foil strain gage wired in a Wheatstone bridge circuit to provide excellent temperature stability. An on-board amplifier is optionally available.

A **PT1000** temperature probe is optionally available for all ranges as a custom design.

On request, Instruction documents can be provided to ease the selection and use of our sensors and provide helpful tips.

XPC10

High temperature miniature pressure sensor

STANDARD RANGES

Ranges (FS)		Pressure Reference			Resonance Frequency ¹²	Sensitivity "FSO" ³	Overpressure	Burst Pressure
bar	psi	Gauge	Abso.	Sealed		(non amplified)	(rated pressure)	(rated pressure)
10 ¹	150 ¹	•	•	•	34 kHz	1.2 mV/V	1.5 x FS	3 x FS
20	300	•	•	•	50 kHz	1.2 mV/V	1.5 x FS	3 x FS
35	500	•	•	•	70 kHz	1.2 mV/V	1.5 x FS	3 x FS
50	750	•	•	•	80kHz	1.2 mV/V	1.5 x FS	3 x FS
70	1K	•	•	•	95 kHz	1.2 mV/V	1.5 x FS	3 x FS
100	1.5K			•	110 kHz	1.2 mV/V	1.5 x FS	3 x FS
200	3K			•	155 kHz	1.2 mV/V	1.5 x FS	3 x FS
350	5K			•	220 kHz	1.2 mV/V	1.5 x FS	3 x FS
500	7.5K			•	250 kHz	1.2 mV/V	1.5 x FS	3 x FS

1. Lower pressure range 5 bar [75 psi] on request as custom design.
2. Useful frequency is 20% of Resonance Frequency. Bandwidth is 600Hz for all A1 amplified version.
3. Sensors are calibrated with 10Vdc power supply as standard.

PERFORMANCE SPECIFICATIONS (all values are typical at ambient temperature 23±3°C)

Parameters	Non amplified ¹	A1	Notes
Power supply	1 to 10 Vdc regulated	10 to 30 Vdc	
Sensitivity "FSO"	See previous table	4 V ±0.2 V	Signal 0.5 - 4.5V for A1 option
Zero Offset	±1 mV	0.5 V ±0.2 V	
Combined Non-Linearity & Hysteresis	±0.5%FS ±0.3%FS ±0.25%FS		FS ≤ 10 bar 10 bar < FS < 100 bar 100 bar ≤ FS
Operating Temperature (OTR)	-40 to 220°C (-40 to 428°F)	-40°C to 120°C (-40°F to 250°F)	
Compensated Temperature (CTR)	0 to 150°C (32 to 300°F)	0 to 80°C (32°F to 170°F)	
Thermal Zero Shift in CTR (TZS)	< ±1%FS/50°C		
Thermal Sensitivity Shift in CTR (TSS)	< ±1% of reading /50°C		
Input Impedance or consumption	500 Ω nom.	< 50 mA	
Output Impedance	350 Ω nom.	1000 Ω	
Ingress Protection	IP50 IP67		Standard or SC option P7 option
Media – Pressure Port	Fluids compatible with stainless steel		

Insulation under 50Vdc ≥100MΩ

CE certification according to EN 61010-1, EN 50081-1, EN 50082-1.

XPC10

High temperature miniature pressure sensor

DIMENSIONS & WIRING SCHEMATIC

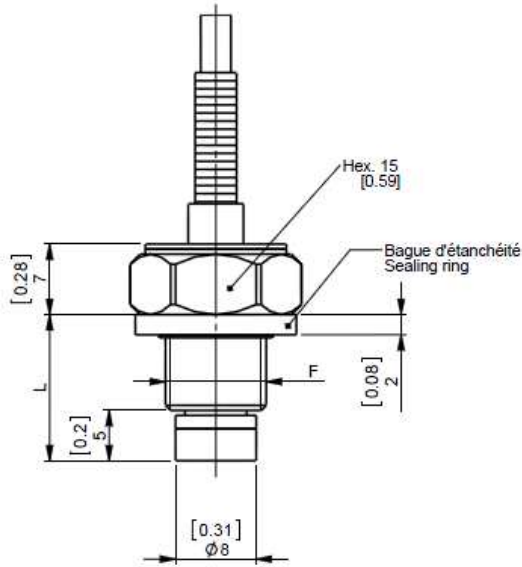

XPC10

Dimensions Metric & Imperial

	XPC10-M	XPC10-X
F (thread)	M10x1	3/8-24UNF
L (mm)	14.5	13.1
L (in)	[0.57]	[0.52]

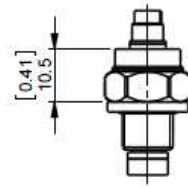

XPC10-*-SC

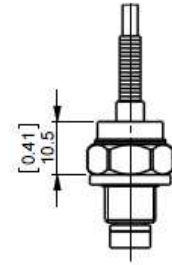

XPC10-*-A1

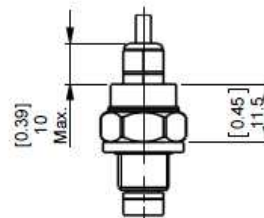

XPC10-*-P7

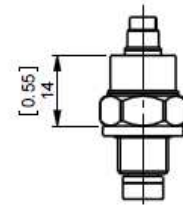

XPC10-*-A1-SC

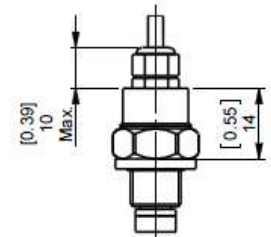

XPC10-*-A1-P7

WIRING AND CONNECTOR OPTION

Not Amplified

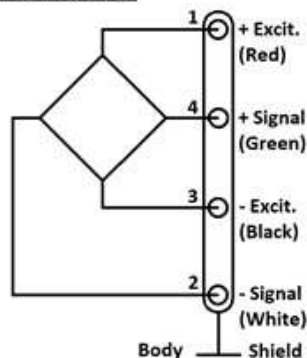

Version A1

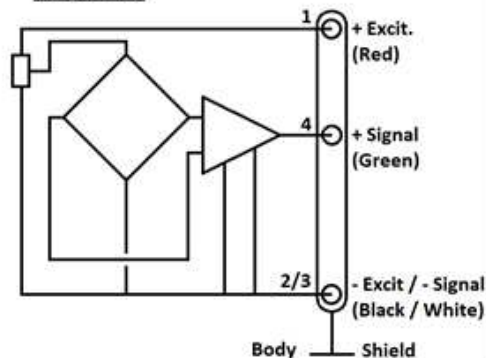

Notes:

1. Recommended Tightening Torque: 5 to 8 Nm (44 to 88 lbf.in)
2. Sealing: One Self-centred "FKM" sealing ring \varnothing 16x2 is supplied with the sensor. Operating temperature is -30°C to 200°C [-20°F to 390°F] static; down to -40°C to 220°C [-40°F to 428°F] for short durations.
3. Electrical connection: Standard = 2m of shielded cable \varnothing 3mm with 4 wires AWG30, Silicon jacket
 SC option = Integral connector ref. Comtronic CMR-02D-04P supplied with mating plug CMR-02-B-04S wired with 2m of cable (FMC-COM-4B-L2M)

XPC10

High temperature miniature pressure sensor

OPTIONS

ZI : Zero shift in CTR <0.75% F.S. / 50 °C [/100 °F]
Z02 : CTR -40 to 60 °C [-40 to 140 ° F]
Z35 : CTR 20 to 120 °C [70 to 250 ° F]
Z38 : CTR +20°C à +200°C [70 to 390°F] (not compatible with A1 and P7 option)
SC : Connector output, mating plug supplied with 2 m cable [6.6 ft]
P7 : IP67 protection / -20°C to +150°C [0°F to 300°F] (not compatible with gauge model)
V00 : Non-standard power supply calibration, replace "00" with value in Volt (standard 10Vdc, unamplified sensor only)
L00M : special cable length, replace "00" with total length in meters (standard length 2,0 m [6,6 ft])

ORDERING INFORMATION

XPC10	-	M	-	A1	-	20B		G	-	/L5M
Model	-	Mounting thread	-	Output signal	-	Pressure Range		Pressure reference	-	Options
XPC10		M : M10x1 X : 3/8-24UNF		(none) : bridge (mV) A1 : 0,5 to 4,5V		10B 20B 35B 50B 70B 100B 200B 350B 500B	150P 300P 500P 750P 1KP 1.5KP 3KP 5KP 7.5KP	A : absolute G : gauge S : sealed		ZI Z02 Z35 Z38 SC P7 L00M

Psi range models only supplied with imperial thread

Bar range models only supplied with metric thread.